

MINIMAL IN VAZIV BYPASS EKARTÖR SETİ

Rescuer

PATENT NO: 2022/017191 ve 2022/017186



KARSAS

KARADENİZ SAĞLIK ANONİM ŞİRKETİ

MINIMAL IN VAZIV BYPASS EKARTÖR SETİ

► LIMA VE BYPASS EKARTÖRÜ

Limanın proksimal kısmının diskisyonunu kolaylaştırır sağlar.
Daha geniş açı sağlayarak üç boyutlu görüntü sağlar.

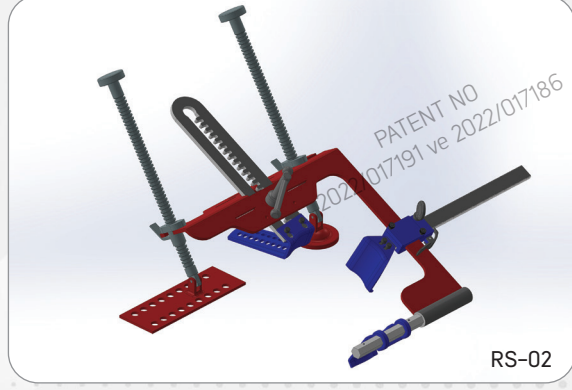
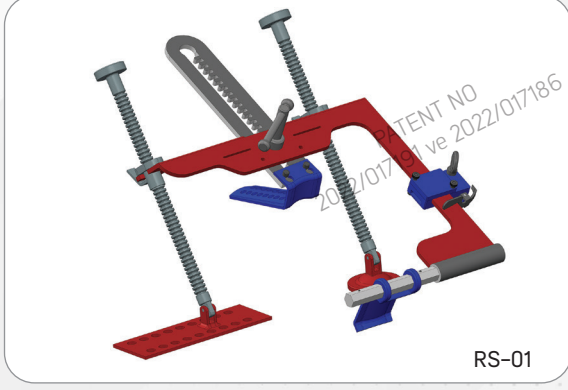

PATENT NO: 2022/017191 ve 2022/017186

► DISTAL EKARTÖRÜ

Limanın distal uzantısının çıkartılmasını sağlar.

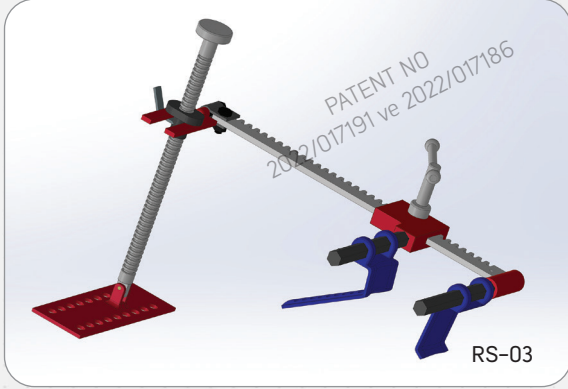







► BLADE TAKIMI



- Minimal invaziv cerrahide yüksek konfor sağlar
- Minimal invaziv cerrahisi uygulamalarında küçük kesi alanından girilerek kaburga altında geniş görüş alanı sağlar.
- Göğüs kafesinin kalp ile arasındaki mesafenin istenilen seviyede ayarlanmasını sağlar.
- Sağladığı geniş 3 boyutlu görüntü sayesinde kalbin 2 tarafında bulunan damarların değişiminin daha kolay ve güvenli yapılmasını sağlar.
- Limanın Proksimal ve distal kısmına rahat ulaşılmasını sağlar.
- By pass esnasında kalbin Aort kısmına kolay ulaşım sağlar.
- By pass esnasında ekartör sisteminde bulunan üçüncü bleyt sistemi ile kalbin sol dış kısmına dayanan akciğeri bloke ederek rahat çalışma alanı sağlar





► MİKRO ŞAFTLI CERRAHİ SETLER

FORCEPS











 1 x 10 mm	 3 x 15 mm	 1,5 x 11 mm	 1,5 x 11 mm	 2,8 x 15 mm	 2,8 x 15 mm	 350 mm		
SUTURE	VALVE	NON-TRAUMATIC				RUSSIAN		
345 mm	350 mm	280 mm	350 mm	350 mm	280 mm	350 mm		
KS-01	KS-02	KS-03	KS-04	KS-05	KS-06	KS-07	KS-08	KS-09

1) WITH LOCK
MIT SPERRE

NEEDLE HOLDERS (WITH LOCK / MIT SPERRE)

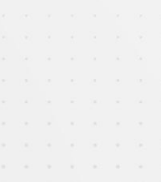
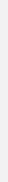
 2 x 10 mm <i>max. 5x0</i>	 3 x 10 mm <i>max. 3x0</i>	 3 x 10 mm <i>max. 2x0</i>	 3 x 10 mm <i>max. 2x0</i>	 1,5 mm <i>max. 5x0</i>			
TCM		TC		TC RYDER			
340 mm	280 mm	340 mm	280 mm	340 mm	280 mm	350 mm	350 mm
KS-10	KS-11	KS-12	KS-13	KS-14	KS-15	KS-16	KS-17

SCISSORS

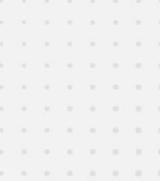
 350 mm	 350 mm	 350 mm	 280 mm	 350 mm	 450 mm	 280 mm	 350 mm	 350 mm
VALVE								
KS-18	KS-19	KS-20	KS-21	KS-22	KS-23	KS-24	KS-25	KS-26
 45°	 45°	 90°	 280 mm	 350 mm				
BLUNT/STUMPF			DISSECTING					
VASCULAR			DISSECTING					
345 mm	345 mm	335 mm	280 mm	350 mm				
KS-27	KS-28	KS-29	KS-30	KS-31				

RS-04

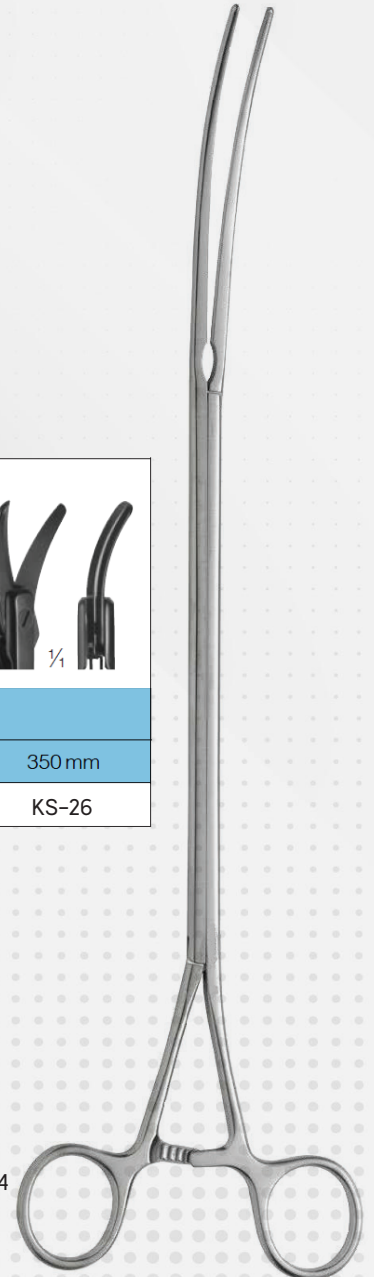

▶ MİKRO ŞAFTLI CERRAHİ SETLER



NON-TRAUMATIC
GRASPING FORCEPS

370 mm

KS-32

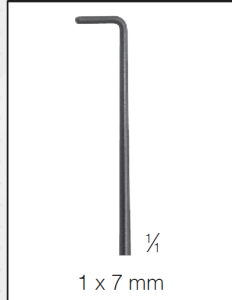
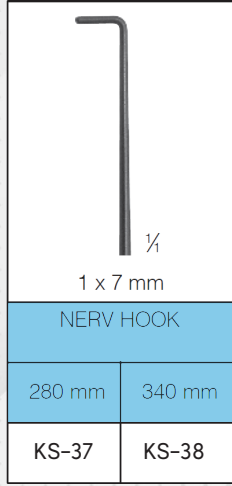

NERV HOOK

280 mm 340 mm

KS-37 KS-38



KNOT PUSHER

280 mm 340 mm

KS-33 KS-34



CLIP APPLIER²¹

370 mm 370 mm

SMALL MEDIUM

KS-35 KS-36

▶ EKLEMLİ EKARTÖR SETİ

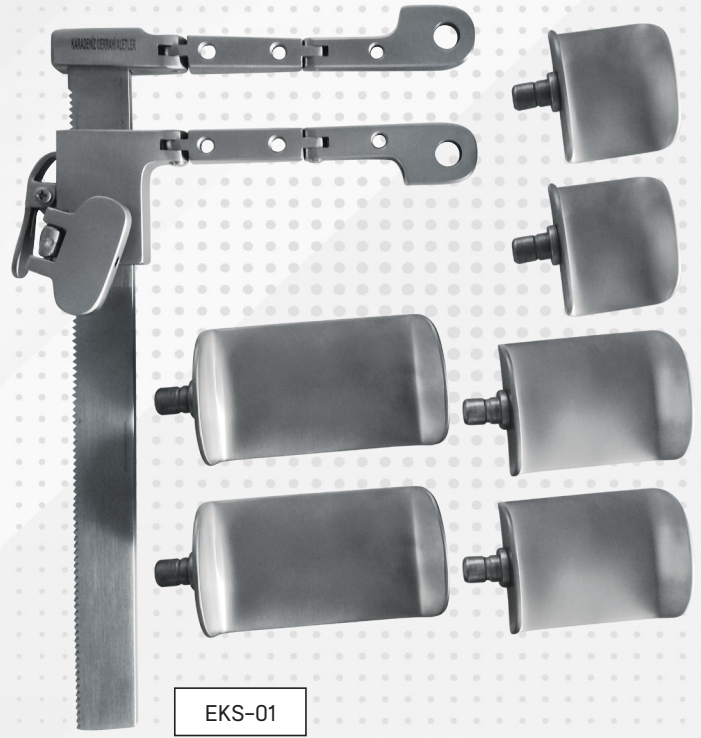

EKS-01

▶ MINIMAL INVAZIV EL ALETLERİ



KARADENİZ SAĞLIK ANONİM ŞİRKETİ

Gsm: 0541 678 15 25 e-Mail: info@karsas.com.tr

Mevlana Mah. Abdullah Gül Bulv. No:89/C Atakum/SAMSUN